



SUNNY

EMERGENCY LIGHT



LIGHT UP
IN THE
DARKNESS

IsOn IMPORT-EXPORT CO.,LTD.

CERTIFICATE



อนุสิทธิบัตร เครื่องไฟฉุกเฉิน
พร้อมไฟสัญญาณแสดงทางออกหนีไฟ
เลขที่ 285 ลว. 29 มิ.ย. 2543

อนุสิทธิบัตร วงจรควบคุม
การคายประจุแบตเตอรี่อัตโนมัติ
เลขที่ 1378 ลว. 21 พ.ค. 2547

อนุสิทธิบัตร เครื่องไฟฉุกเฉินพร้อมวงจร
ควบคุมการคายประจุแบตเตอรี่อัตโนมัติ
เลขที่ 2062 ลว. 27 ต.ค. 2548



มอก. 1102-2538
โคมไฟฉุกเฉินชุดเบ็ดเสร็จ

มอก. 1955-2551
บริษัททั้งสองสว่าง และบริษัทที่คล้ายกัน
: ชีตจำกัด สัญญาฉบับรวมวิทยุ

มอก. 1291-2545
ระบบกำลังไฟฟ้าต่อเนื่อง



มาตรฐาน ISO 9001 : 2008
จาก GLOBAL



SELF-CONTAINED EMERGENCY LIGHTING LUMINAIRES



8 MCU
SELF-CONTAINED EMERGENCY
LIGHTING LUMINAIRES

9 NAU
SELF-CONTAINED EMERGENCY
LIGHTING LUMINAIRES

11 SAU
SELF-CONTAINED EMERGENCY
LIGHTING LUMINAIRES

13 SN
SELF-CONTAINED EMERGENCY
LIGHTING LUMINAIRES

15 CCU
NON-MAINTAINED SYSTEM
CENTRAL BATTERY CONTROL UNIT

17 INVERTER
MAINTAINED SYSTEM CENTRAL
BATTERY CONTROL UNIT HIGH VOLTAGE

TYPES OF LAMP

DH



รองรับหลอด

LED MR16 GU5.3,
Dichroic Halogen Lamp,

ทิศทางการปรับหัวโคม

แนวนอน สามารถปรับได้มากกว่า 180°
แต่ไม่เกิน 360°
แนวตั้ง ปรับได้มากกว่า 90° แต่ไม่เกิน 180°

ตัวโคม

ทำจากอลูมิเนียม ฉีดขึ้นรูปด้วยสีฝุ่น
อบด้วยความร้อน ไม่ก่อให้เกิดสนิม

การใช้งาน

เหมาะสำหรับการให้แสงสว่างในพื้นที่
ที่จำกัดและต้องการให้แสงสว่างส่องไปใน
ระยะทางพุ่งตรง เช่นทางเดิน เส้นทางหนีไฟ
คลังสินค้า อาคารบ้านเรือน เป็นต้น

CL



รองรับหลอด

Tungsten Halogen Lamp

ทิศทางการปรับหัวโคม

แนวนอน สามารถปรับได้มากกว่า 180°
แต่ไม่เกิน 360°
แนวตั้ง ปรับได้มากกว่า 90° แต่ไม่เกิน 180°

ตัวโคม

ทำจากโลหะปั๊มขึ้นรูปด้วยสีฝุ่น
อบด้วยความร้อน ไม่ก่อให้เกิดสนิม

การใช้งาน

เหมาะสำหรับการให้แสงสว่างที่กระจาย
กว้างทั่วทั้งห้อง แต่ระยะการส่องสว่าง
ไม่ไกลมากนัก เช่นห้องโถง ห้องประชุม
คลังสินค้า ออฟฟิศ ในตัวอาคารหรือ
บ้านเรือน เป็นต้น

SM



รองรับหลอด

Tungsten Halogen Lamp

ทิศทางการปรับหัวโคม

แนวนอน สามารถปรับได้มากกว่า 180°
แต่ไม่เกิน 360°
แนวตั้ง ปรับได้มากกว่า 90° แต่ไม่เกิน 180°

ตัวโคม

ทำจากโลหะปั๊มขึ้นรูปด้วยสีฝุ่น
อบด้วยความร้อน ไม่ก่อให้เกิดสนิม

การใช้งาน

เหมาะสำหรับการให้แสงสว่างที่กระจาย
กว้างทั่วทั้งห้อง และระยะการส่องสว่างไกล
เช่นห้องโถงขนาดใหญ่ ห้องประชุมขนาดใหญ่
คลังสินค้าขนาดใหญ่ โรงงาน ลานจอดรถ
ในตัวอาคาร ออฟฟิศ หรือบ้านเรือน เป็นต้น

TYPES OF BULB

MR 16-3W LED



MR 16-6W LED



MR 16-10W LED



MR 16 HALOGEN



JC HALOGEN



MCU SERIES

MCU SPECIFICATION

- MODE OPERATION :** Non-Maintained
INPUT VOLTAGE : 220 Vac. 50 Hz +/- 10%
CONTROL SYSTEM : Micro controller Unit (MCU) 8bit Full Function control System
LIGHTING UNIT : LED MR16 12V
TYPE OF BATTERY : SUNNY Sealed lead Acid Maintenance Free.
 ISO 9001 & Certified CE and UL Underwriters Laboratories Inc.
BATTERY CHARGE : Automatic Battery Charger, Solid-State Trickle Charge, Constant Voltage
CHARGING PERIOD : 10-15 Hours
PROTECTIONS : AC Fuse to prevent short circuit and over load for AC Input
 DC Fuse to prevent short circuit and over load for DC Output
 Low Voltage Cut-Off protects Battery
 Under Voltage Input prevent the AC Main supply is less than 140-160 Vac.
 Lamps will automatically switch to the battery Powered operation.
 Main Power Switch to control the output emergency light
HOUSING : Zinc Steel Sheet 1 mm. Thickness with Epoxy Powder and Stove Enamel.
 Anti-rust corrosion proof
INDICATORS : LED AC/DC indicates incoming 220VAC. or 12Vdc.
 LED Charging/Fully indicates incoming the battery charging or fully charge.
 LED Auto Test indicates automatic test system.
 LED Fail indicates fail to test half year and monthly.
 LED Voltage Level indicates level voltage battery.
 LED Back up indicates backup time.
 LED IR Receiver indicates infrared receiver.

MULTI FUNCTION TEST :

- NORMAL TEST :** Test battery 5 seconds discharge.
MONTHLY TEST: Test battery 30 minutes discharge.
HALF YEAR TEST: Test battery 60 minutes discharge.
ON/OFF: on/off lamp or cancel program test.
REMOTE TESTING: Multi Function test. Normal Test, Monthly Test, Half Year Test, ON/OFF
AUTOMATIC TEST SYSTEM: Monthly Test battery.30 minutes.
 Half Year Test battery 60 minutes.

CONNECTION INTERFACE :



Port RS232

LED MR 16 Series For MCU 8 bit

MODEL	LAMP		BATTERY CAPACITY	BACK UP (Hours)	DIMENSION (mm.)				WEIGHT (kgs.)
	BULB	WATT			L	W	H	HL	
MCU 203DH2LED	2	3	12V - 1.2Ah.	2	255	80	150	265	3.1
MCU 203DH4LED	2	3	12V - 2.8Ah.	4	255	80	150	265	3.7
MCU 203DH6LED	2	3	12V - 4.5Ah.	6	255	80	180	300	4.3
MCU 203DH12LED	2	3	12V - 7Ah.	12	295	80	180	300	5.6
MCU 203DH15LED	2	3	12V - 9Ah.	15	295	80	180	300	6.9
MCU 206DH2LED	2	6	12V - 2.8Ah.	2	255	80	150	265	3.7
MCU 206DH3LED	2	6	12V - 4.5Ah.	3	255	80	180	300	4.3
MCU 206DH5LED	2	6	12V - 7Ah.	5	295	80	180	300	5.6
MCU 206DH6LED	2	6	12V - 9Ah.	6	295	80	180	300	6.9
MCU 210DH2LED	2	10	12V - 4.5Ah.	2.5	255	80	180	300	4.3
MCU 210DH3LED	2	10	12V - 7.5Ah.	3.5	295	80	180	300	5.7
MCU 210DH4LED	2	10	12V - 9Ah.	4.5	295	80	180	300	6.9



Status	Voltage Level	Back-up (mins)
AC/DC	Max	120
Charging / Fully	High	90
Auto Test	Medium	60
Fail	Low	30

MULTI FUNCTION TEST			ON/OFF	IR Receiver
Normal	Monthly	Half Year		
5 secs	30 mins	60 mins		

NAU LED SERIES

NEW



NAU LED SPECIFICATION

- MODE OPERATION :** Non-Maintained
INPUT VOLTAGE : 220 Vac. 50 Hz +/- 10%
LIGHTING UNIT : Dichroic Power LED Lamp Sealed Beam
TYPE OF BATTERY : SUNNY Sealed lead Acid Maintenance Free, ISO 9001 & Certified CE and UL Underwriters Laboratories Inc.
BATTERY CHARGE : Automatic Battery Charger, Solid-State Trickle Charge, Constant Voltage limiting current.
CHARGING PERIOD : 10-15 Hours.
PROTECTIONS : AC Fuse to prevent short circuit and over load for AC Input
 DC Fuse to prevent short circuit and over load for DC Output
 Low Voltage Cut-Off protects Battery
 Under Voltage Input prevent the AC Main supply is less than 140-160 Vac.
 Lamps will automatically switch to the battery Powered operation
INDICATORS : LED AC indicates incoming 220Vac.
 LED CHARGE indicates the battery is charging.
 LED FULL indicates the battery is fully charging.
 LED OVER indicates the battery over charging.
 SWITCH TEST test the output lamp and battery.
 SWITCH L on lamp left, SWITCH R on lamp right.
 SWITCH OFF off output lamp.
 SWITCH ON on output lamp (single lamp)
HOUSING : Zinc Steel Sheet 1 mm. Thickness with Epoxy Powder and Stove Enamel Anti-rust corrosion proof

MODEL	LAMP		BATTERY CAPACITY	BACK UP (Hours)	DIMENSION (mm.)				WEIGHT (kgs.)
	BULB	WATT			L	W	H	HL	
NAU 103DH4LED	1	3	12V - 1.2Ah.	4	130	85	185	290	1.8
NAU 203DH2LED	2	3	12V - 1.2Ah.	2	255	80	150	265	3.1
NAU 203DH4LED	2	3	12V - 2.8Ah.	4	255	80	150	265	3.6
NAU 203DH6LED	2	3	12V - 4.5Ah.	6	255	80	180	300	4.3
NAU 203DH12LED	2	3	12V - 7Ah.	12	295	80	180	300	5.6
NAU 203DH15LED	2	3	12V - 9Ah.	15	295	80	180	300	6.9

NAU HALOGEN SERIES

NAU SPECIFICATION

- MODE OPERATION :** Non-Maintained
INPUT VOLTAGE : 220 Vac. 50 Hz +/- 10%
LIGHTING UNIT : Dichroic Halogen and Halogen Lamp Sealed Beam
TYPE OF BATTERY : SUNNY Sealed lead Acid Maintenance Free, ISO 9001 & Certified CE and UL Underwriters Laboratories Inc.
BATTERY CHARGE : Automatic Battery Charger, Solid-State Trickle Charge, Constant Voltage limiting current.
CHARGING PERIOD : 10-15 Hours.
PROTECTIONS : AC Fuse to prevent short circuit and over load for AC Input,
 DC Fuse to prevent short circuit and over load for DC Output.
 Low Voltage Cut-Off protects Battery.
 Under Voltage Input prevent the AC Main supply is less than 140-160 Vac.
 Lamps will automatically switch to the battery Powered operation
INDICATORS : LED AC indicates incoming 220Vac.
 LED CHARGE indicates the battery is charging.
 LED FULL indicates the battery is fully charging.
 LED OVER indicates the battery over charging.
 SWITCH TEST test the output lamp and battery.
 SWITCH L on lamp left.
 SWITCH R on lamp right.
 SWITCH OFF off output lamp.
HOUSING : Zinc Steel Sheet 1 mm. Thickness with Epoxy Powder and Stove Enamel. Anti-rust corrosion proof

NAU Series DH TYPE



DH TYPE

MODEL	LAMP		BATTERY CAPACITY	BACK UP (Hours)	DIMENSION (mm.)				WEIGHT (kgs.)
	BULB	WATT			L	W	H	HL	
NAU 220 DH 1	2	20	12V - 7Ah.	1.50	295	80	180	300	5.6
NAU 225 DH 1	2	25	12V - 7Ah.	1.00	295	80	180	300	5.6
NAU 220 DH 2	2	20	12V - 9Ah.	2.00	295	80	180	300	6.9
NAU 225 DH 1	2	25	12V - 9Ah.	1.50	295	80	180	300	6.9
NAU 220 DH 3	2	20	12V - 12Ah.	3.00	295	110	180	310	7.3
NAU 225 DH 2	2	25	12V - 12Ah.	2.00	295	110	180	310	7.3
NAU 235 DH 1	2	35	12V - 12Ah.	1.50	295	110	180	310	7.3
NAU 255 DH 1	2	55	12V - 12Ah.	1.00	295	110	180	310	7.3
NAU 235 DH 2	2	35	12V - 15Ah.	2.00	335	95	215	345	9.7
NAU 220 DH 4	2	20	12V - 18Ah.	4.00	335	95	215	345	9.9
NAU 235 DH 3	2	35	12V - 18Ah.	3.00	335	95	215	345	9.9
NAU 250 DH 2	2	50	12V - 21Ah.	2.00	335	95	215	345	10.7
NAU 235 DH 3	2	35	12V - 26Ah.	3.50	350	140	225	356	13.9
NAU 250 DH 2	2	50	12V - 26Ah.	2.30	350	140	225	356	13.9
NAU 255 DH 2	2	55	12V - 26Ah.	2.00	350	140	225	356	13.9

NAU Series CL TYPE



CL TYPE

MODEL	LAMP		BATTERY CAPACITY	BACK UP (Hours)	DIMENSION (mm.)				WEIGHT (kgs.)
	BULB	WATT			L	W	H	HL	
NAU 220 CL 1	2	20	12V - 7Ah.	1.50	295	80	180	350	5.6
NAU 225 CL 1	2	25	12V - 7Ah.	1.00	295	80	180	350	5.6
NAU 220 CL 2	2	20	12V - 9Ah.	2.00	295	80	180	350	6.9
NAU 225 CL 1	2	25	12V - 9Ah.	1.50	295	80	180	350	6.9
NAU 220 CL 3	2	20	12V - 12Ah.	3.00	295	110	180	350	7.3
NAU 225 CL 2	2	25	12V - 12Ah.	2.00	295	110	180	350	7.3
NAU 235 CL 1	2	35	12V - 12Ah.	1.50	295	110	180	350	7.3
NAU 255 CL 1	2	55	12V - 12Ah.	1.00	295	110	180	350	7.3
NAU 235 CL 2	2	35	12V - 15Ah.	2.00	335	95	215	385	9.7
NAU 220 CL 4	2	20	12V - 18Ah.	4.00	335	95	215	385	9.9
NAU 235 CL 3	2	35	12V - 18Ah.	3.00	335	95	215	385	9.9
NAU 250 CL 2	2	50	12V - 21Ah.	2.00	335	95	215	385	10.7
NAU 235 CL 3	2	35	12V - 26Ah.	3.50	350	140	225	395	13.9
NAU 250 CL 2	2	50	12V - 26Ah.	2.30	350	140	225	395	13.9
NAU 255 CL 2	2	55	12V - 26Ah.	2.00	350	140	225	395	13.9

NAU Series SM TYPE



SM TYPE

MODEL	LAMP		BATTERY CAPACITY	BACK UP (Hours)	DIMENSION (mm.)				WEIGHT (kgs.)
	BULB	WATT			L	W	H	HL	
NAU 220 SM 1	2	20	12V - 7Ah.	1.50	295	80	180	310	5.6
NAU 225 SM 1	2	25	12V - 7Ah.	1.00	295	80	180	310	5.6
NAU 220 SM 2	2	20	12V - 9Ah.	2.00	295	80	180	310	6.9
NAU 225 SM 1	2	25	12V - 9Ah.	1.50	295	80	180	310	6.9
NAU 220 SM 3	2	20	12V - 12Ah.	3.00	295	110	180	310	7.3
NAU 225 SM 2	2	25	12V - 12Ah.	2.00	295	110	180	310	7.3
NAU 235 SM 1	2	35	12V - 12Ah.	1.50	295	110	180	310	7.3
NAU 255 SM 1	2	55	12V - 12Ah.	1.00	295	110	180	310	7.3
NAU 235 SM 2	2	35	12V - 15Ah.	2.00	335	95	215	345	9.7
NAU 220 SM 4	2	20	12V - 18Ah.	4.00	335	95	215	345	9.9
NAU 235 SM 3	2	35	12V - 18Ah.	3.00	335	95	215	345	9.9
NAU 250 SM 2	2	50	12V - 21Ah.	2.00	335	95	215	345	10.7
NAU 235 SM 3	2	35	12V - 26Ah.	3.50	350	140	225	356	13.9
NAU 250 SM 2	2	50	12V - 26Ah.	2.30	350	140	225	356	13.9
NAU 255 SM 2	2	55	12V - 26Ah.	2.00	350	140	225	356	13.9

SAU SERIES



DH TYPE



CL TYPE



SM TYPE

SAU SPECIFICATION

- MODE OPERATION :** Non-Maintained
INPUT VOLTAGE : 220 Vac. 50 Hz +/- 10%
LIGHTING UNIT : Dichroic Halogen and Halogen Lamp Sealed Beam
TYPE OF BATTERY : SUNNY Sealed lead Acid Maintenance Free, ISO 9001 & Certified CE and UL Underwriters Laboratories Inc.
BATTERY CHARGE : Automatic Battery Charger, Solid-State Trickle Charge, Constant Voltage limiting current.
CHARGING PERIOD : 10-15 Hours.
PROTECTIONS : AC Fuse to prevent short circuit and over load for AC Input
 DC Fuse to prevent short circuit and over load for DC Output
 Low Voltage Cut-Off protects Battery
INDICATORS : LED AC indicates incoming 220 Vac.
 LED CHARGE indicates the battery is charging
 SWITCH TEST test battery and output lamps
 SWITCH ON on output lamps
 SWITCH OFF off output lamps
HOUSING : Zinc Steel Sheet 1 mm. Thickness with Epoxy Powder and Stove Enamel. Anti-rust corrosion proof

MODEL	LAMP		BATTERY CAPACITY	BACK UP (Hours)	DIMENSION (mm.)				WEIGHT (kgs.)
	BULB	WATT			L	W	H	HL	
SAU 106 DH 3	1	6	6V - 4.5Ah.	3	130	85	185	305	3.5
SAU 110 DH 2	1	10	6V - 4.5Ah.	2	130	85	185	305	3.5
SAU 106 CL 3	1	6	6V - 4.5Ah.	3	130	85	185	355	3.5
SAU 110 CL 2	1	10	6V - 4.5Ah.	2	130	85	185	355	3.5
SAU 106 SM 3	1	6	6V - 4.5Ah.	3	130	85	185	305	3.5
SAU 110 SM 2	1	10	6V - 4.5Ah.	2	130	85	185	305	3.5

SAU SPECIFICATION

- MODE OPERATION :** Non-Maintained
INPUT VOLTAGE : 220 Vac. 50 Hz +/- 10%
LIGHTING UNIT : Dichroic Halogen and Halogen Lamp Sealed Beam
TYPE OF BATTERY : SUNNY Sealed lead Acid Maintenance Free, ISO 9001 & Certified CE and UL Underwriters Laboratories Inc.
BATTERY CHARGE : Automatic Battery Charger, Solid-State Trickle Charge, Constant Voltage limiting current.
CHARGING PERIOD : 10-15 Hours.
PROTECTIONS : AC Fuse to prevent short circuit and over load for AC Input.
 DC Fuse to prevent short circuit and over load for DC Output.
 Low Voltage Cut-Off protects Battery.

Under Voltage Input prevent the AC Main supply is less than 140-160 Vac.

Lamps will automatically switch to the battery Powered operation

- INDICATORS :** LED AC indicates incoming 220Vac.
 LED CHARGE indicates the battery is charging.
 LED FULL indicates the battery is fully charging.
 LED OVER indicates the battery over charging.
 SWITCH TEST test the output lamp and battery.
 SWITCH L on lamp left.
 SWITCH R on lamp right.
 SWITCH OFF off output lamp.

HOUSING : Zinc Steel Sheet 1 mm. Thickness with Epoxy Powder and Stove Enamel. Anti-rust corrosion proof

DH TYPE



DH TYPE

MODEL	LAMP		BATTERY CAPACITY	BACK UP (Hours)	DIMENSION (mm.)				WEIGHT (kgs.)
	BULB	WATT			L	W	H	HL	
SAU 235 DH 2	2	35	12V - 15Ah.	2	390	100	250	370	12.7
SAU 235 DH 3	2	35	12V - 18Ah.	3	390	100	250	370	13.3
SAU 250 DH 2	2	50	12V - 21Ah.	2	390	100	250	370	13.6
SAU 235 DH 3	2	35	12V - 26Ah.	3.5	400	155	260	380	17.8
SAU 250 DH 2	2	50	12V - 26Ah.	2.3	400	155	260	380	17.8
SAU 255 DH 2	2	55	12V - 26Ah.	2	400	155	260	380	17.8
SAU 235 DH 4	2	35	12V - 33Ah.	4	400	155	260	380	20.6
SAU 250 DH 3	2	50	12V - 33Ah.	3	400	155	260	380	20.6
SAU 220 DH 9	2	20	12V - 40Ah.	9	400	190	260	380	30.0
SAU 225 DH 7	2	25	12V - 40Ah.	7	400	190	260	380	30.0
SAU 235 DH 5	2	35	12V - 40Ah.	5	400	190	260	380	30.0
SAU 255 DH 3	2	55	12V - 40Ah.	3	400	190	260	380	30.0

CL TYPE



CL TYPE

MODEL	LAMP		BATTERY CAPACITY	BACK UP (Hours)	DIMENSION (mm.)				WEIGHT (kgs.)
	BULB	WATT			L	W	H	HL	
SAU 235 CL 2	2	35	12V - 15Ah.	2	390	100	250	420	12.7
SAU 235 CL 3	2	35	12V - 18Ah.	3	390	100	250	420	13.3
SAU 250 CL 2	2	50	12V - 21Ah.	2	390	100	250	420	13.6
SAU 235 CL 3	2	35	12V - 26Ah.	3.5	400	155	260	430	17.8
SAU 250 CL 2	2	50	12V - 26Ah.	2.3	400	155	260	430	17.8
SAU 255 CL 2	2	55	12V - 26Ah.	2	400	155	260	430	17.8
SAU 235 CL 4	2	35	12V - 33Ah.	4	400	155	260	430	20.6
SAU 250 CL 3	2	50	12V - 33Ah.	3	400	155	260	430	20.6
SAU 220 CL 9	2	20	12V - 40Ah.	9	400	190	260	430	30.0
SAU 225 CL 7	2	25	12V - 40Ah.	7	400	190	260	430	30.0
SAU 235 CL 5	2	35	12V - 40Ah.	5	400	190	260	430	30.0
SAU 255 CL 3	2	55	12V - 40Ah.	3	400	190	260	430	30.0

SM TYPE



SM TYPE

MODEL	LAMP		BATTERY CAPACITY	BACK UP (Hours)	DIMENSION (mm.)				WEIGHT (kgs.)
	BULB	WATT			L	W	H	HL	
SAU 235 SM 2	2	35	12V - 15Ah.	2	390	100	250	370	12.7
SAU 235 SM 3	2	35	12V - 18Ah.	3	390	100	250	370	13.3
SAU 250 SM 2	2	50	12V - 21Ah.	2	390	100	250	370	13.6
SAU 235 SM 3	2	35	12V - 26Ah.	3.5	400	155	260	380	17.8
SAU 250 SM 2	2	50	12V - 26Ah.	2.3	400	155	260	380	17.8
SAU 255 SM 2	2	55	12V - 26Ah.	2	400	155	260	380	17.8
SAU 235 SM 4	2	35	12V - 33Ah.	4	400	155	260	380	20.6
SAU 250 SM 3	2	50	12V - 33Ah.	3	400	155	260	380	20.6
SAU 220 SM 9	2	20	12V - 40Ah.	9	400	190	260	380	30.0
SAU 225 SM 7	2	25	12V - 40Ah.	7	400	190	260	380	30.0
SAU 235 SM 5	2	35	12V - 40Ah.	5	400	190	260	380	30.0
SAU 255 SM 3	2	55	12V - 40Ah.	3	400	190	260	380	30.0

SN SERIES



SN 156 DH 1



SN 206 DH 3



SN 206 DH 3X



SN-N SERIES

SN SPECIFICATION

- INPUT :** 220 Vac. 50 Hz +/- 10%
- LIGHTING UNIT :** Halogen, Dichroic Halogen Lamp Sealed Beam
- TYPE OF BATTERY :** SUNNY Sealed lead Acid Maintenance Free, ISO 9001 & Certified CE and UL Underwriters Laboratories Inc.
- BATTERY CHARGER :** Automatic Battery Charger, Solid-State Cycle Charge, Constant Voltage limiting current.
- CHARGING PERIOD :** 10 -15 Hours.
- PROTECTIONS :** Low / High Battery Charger Cut-Off. Under Voltage Cut-Off
AC Fuse to prevent short circuit and over load for AC Input
DC Fuse to prevent short circuit and over load for DC Output
- HOUSING :** Zinc Steel Sheet 1 mm. Thickness with Epoxy Powder and Stove Enamel coated. Anti-rust corrosion proof
- INDICATORS :** LED AC POWER or AC indicates incoming 220Vac.
LED CHARGE or Charging indicates the battery is charging.
LED FULL indicates the battery is fully charging.
LED OVER indicates the battery over charging.
SWITCH TEST test the output lamp and battery.
SWITCH ON/OFF control the output lamps.
- OPTIONS :** Automatic Test-Monthly Exercise
Remote Test-Wireless
Sealed Nickel Cadmium Battery, Maintenance Free
Single / Double Remote Head Lamp for Wall or Ceiling-mounted
Time Delay 1 up to 15 minutes
DC Voltmeter, DC Ammeter Flashing Sign Light (X type)

MODEL	LAMP		BATTERY CAPACITY	BACK UP (Hours)	DIMENSION (mm.)				WEIGHT (kgs.)
	BULB	WATT			L	W	H	HL	
SN 235 DH 2 N	2	35	12V - 15Ah.	2	400	117	237	357	11.2
SN 235 CL 2 N	2	35	12V - 15Ah.	2	400	117	237	407	11.2
SN 235 SM 2 N	2	35	12V - 15Ah.	2	400	117	237	357	11.2
SN 220 DH 4 N	2	20	12V - 18Ah.	4	400	117	237	357	11.6
SN 235 DH 3 N	2	35	12V - 18Ah.	3	400	117	237	357	11.6
SN 220 CL 4 N	2	20	12V - 18Ah.	4	400	117	237	407	11.6
SN 235 CL 3 N	2	35	12V - 18Ah.	3	400	117	237	407	11.6
SN 220 SM 4 N	2	20	12V - 18Ah.	4	400	117	237	357	11.6
SN 235 SM 3 N	2	35	12V - 18Ah.	3	400	117	237	357	11.6
SN 250 DH 2 N	2	50	12V - 21Ah.	2	400	117	237	357	12.4
SN 250 CL 2 N	2	50	12V - 21Ah.	2	400	117	237	407	12.4
SN 250 SM 2 N	2	50	12V - 21Ah.	2	400	117	237	357	12.4
SN 235 DH 3 N	2	35	12V - 26Ah.	3.5	430	143	250	370	17.6
SN 255 DH 2 N	2	55	12V - 26Ah.	2	430	143	250	370	17.6
SN 235 CL 3 N	2	35	12V - 26Ah.	3.5	430	143	250	420	17.6
SN 255 CL 2 N	2	55	12V - 26Ah.	2	430	143	250	420	17.6
SN 235 SM 3 N	2	35	12V - 26Ah.	3.5	430	143	250	370	17.6
SN 255 SM 2 N	2	55	12V - 26Ah.	2	430	143	250	370	17.6
SN 235 DH 4 N	2	35	12V - 33Ah.	4	430	143	250	370	20.4
SN 255 DH 2 N	2	55	12V - 33Ah.	2.5	430	143	250	370	20.4
SN 235 CL 4 N	2	35	12V - 33Ah.	4	430	143	250	420	20.4
SN 255 CL 2 N	2	55	12V - 33Ah.	2.5	430	143	250	420	20.4
SN 235 SM 4 N	2	35	12V - 33Ah.	4	430	143	250	370	20.4
SN 255 SM 2 N	2	55	12V - 33Ah.	2.5	430	143	250	370	20.4
SN 156 DH 1	2	6	6V - 4.5Ah.	1.5	255	80	180	300	5
SN 206 DH 3	2	6	6V - 4.5Ah.x2	3	300	80	180	300	5.58
SN 206 DH 3 X	2	6	6V - 4.5Ah.x2	3	300	80	180	300	5.58
SN 206 SM 3	2	6	6V - 4.5Ah.x2	3	300	80	180	300	5.58
SN 206 SM 3 X	2	6	6V - 4.5Ah.x2	3	300	80	180	300	5.58

SN SERIES

NON-MAINTAINED SYSTEM CENTRAL BATTERY CONTROL UNIT



CONTROL 5 POINTS



CONTROL 10 POINTS

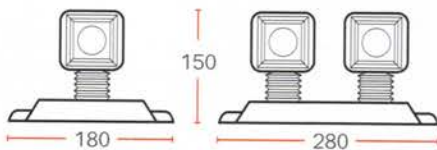

DIAGRAM

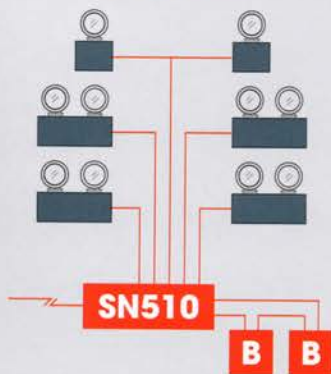

CCU CCU SERIES

 REMOTE HEAD LED LAMP
1x35 WATT

 REMOTE HEAD LED LAMP
2x35 WATT

 2 BATTERIES SERIES
TO 24 VDC.

SN SPECIFICATION

MODE OPERATION : Non-Maintained

VOLTAGE INPUT : 220 VAC. 50 Hz +/- 10%

LIGHTING UNIT : Halogen, Dichroic Halogen, LED MR16 12V
or Sealed Beam with adjustable and rubber anti-dust.
The lamps are mounting on single or double breaker that
can be installed in both wall or ceiling-mounted.

TYPE OF BATTERY : SUNNY sealed lead acid maintenance free,
ISO9001 & Certified CE and UL Underwriters Laboratories Inc.

BATTERY CHARGER : Automatic Battery Charger, Solid-State, Trickle Charge,
Constant Voltage Limiting Current

CHARGING PERIOD : 10 - 15 Hours.

PROTECTIONS : Low / High Battery Charger Cut-Off.
Over / Under Voltage Cut-Off. (SN Halogen Series)
AC Fuse to prevent short circuit and overload for AC Output
DC Fuse to prevent short circuit and overload for DC Output

INDICATORS : LED AC incoming 220 Vac.

LED CHARGE indicates charging status

LED FULL indicates battery is fully charged

CONTROL : ON / OFF switch to control the output lamp individually

OPTIONS : TEST BUTTON to test the output lamps.

Automatic Test - Monthly Exercise.

Remote Test - Wireless.

Time Delay 1 up to 15 Minutes.

LED SERIES

MODEL	VOLTAGE OUTPUT (VDC)	DC OUTPUT		BATTERY CAPACITY	BACK UP (Hours)	DIMENSION (mm.)			WEIGHT (kgs.)
		POWER	ZONE			L	W	H	
SN 5-2 LED	12	1x3, 2x3	10, 5	12V - 9Ah.	2	435	155	265	9.5
SN 5-4 LED	12	1x3, 2x3	10, 5	12V - 18Ah.	4	435	155	265	13
SN 5-6 LED	12	1x3, 2x3	10, 5	12V - 26Ah.	6	435	155	265	15
SN 10-2 LED	12	1x3, 2x3	20, 10	12V - 18Ah.	2	435	155	265	13
SN 10-4 LED	12	1x3, 2x3	20, 10	12V - 26Ah.	4	435	155	265	15

HALOGEN SERIES

MODEL	DC OUTPUT		BATTERY CAPACITY	BACK UP (Hours)	DIMENSION (mm.)			WEIGHT (kgs.)
	WATT	ZONE			L	W	H	
SN 1020	1x35	20	12V - 150Ah.	2	435	155	265	10
SN 1020	2x35	10	12V - 150Ah.	2	435	155	265	10
SN 510	1x35	10	12V - 80Ah.	2	435	155	265	9
SN 510	2x35	5	12V - 80Ah.	2	435	155	265	9
SN 1020	1x35	20	24V - 65Ah.	1.5	435	155	265	10
SN 1020	2x35	10	24V - 80Ah.	2	435	155	265	10
SN 510	1x35	10	24V - 40Ah.	2	435	155	265	9
SN 510	2x35	5	24V - 65Ah.	3	435	155	265	9

* Halogen series the battery outside

CCU LED SERIES

NON-MAINTAINED SYSTEM
CENTRAL BATTERY CONTROL UNIT



NEW



DIAGRAM

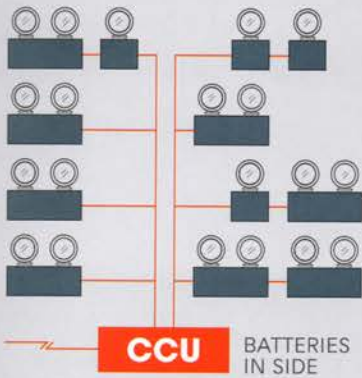

CCU CCU SERIES

○ REMOTE HEAD LED LAMP
■ 1X3 WATT 12 VOLT

○ ○ REMOTE HEAD LED LAMP
■ 2X3 WATT 12 VOLT

CCU LED SPECIFICATION

MODE OPERATION : Non-Maintained

INPUT VOLTAGE : 220 Vac. 50 Hz +/- 10%

LIGHTING UNIT : Power LED Lamp Sealed Beam

TYPE OF BATTERY : SUNNY Sealed lead Acid Maintenance Free

ISO 9001 & Certified CE and UL Underwriters Laboratories Inc.

BATTERY CHARGE : Automatic Battery Charger, Solid-State Trickle Charge,
Constant Voltage limiting current.

CHARGING PERIOD : 10-15 Hours.

PROTECTIONS : AC Fuse to prevent short circuit and over load for AC Input.
DC Fuse to prevent short circuit and over load for DC Output.
Low Voltage Cut-off protects battery.

Under Voltage Input prevent the AC Main supply is less than 140-160 Vac.
lamps will automatically switch to the battery powered operation.

INDICATORS : LED AC indicates incoming 220Vac.

LED CHARGE indicates the battery is charging.

LED FULL indicates the battery is fully charging.

LED OVER indicates the battery over charging.

SWITCH TEST test the output lamp and battery.

SWITCH L on lamp left.

SWITCH R on lamp right.

SWITCH OFF off output lamp.

HOUSING : Zinc Steel Sheet 1 mm. Thickness with Epoxy Powder
and Stove Enamel. Anti-rust corrosion proof

MODEL	LAMP		BATTERY CAPACITY	BACK UP (Hours)	DIMENSION (mm.)			WEIGHT (kgs.)
	BULB	WATT			L	W	H	
CCU 12 - 10 LED	10	30	12V - 7Ah.	2.0	295	80	180	5.6
CCU 12 - 18 LED	18	54	12V - 12Ah.	2.0	295	110	180	7.3
CCU 12 - 22 LED	22	66	12V - 15Ah.	2.0	390	100	250	12.7
CCU 12 - 36 LED	36	108	12V - 26Ah.	2.0	400	155	260	17.8

CCU SERIES

NON-MAINTAINED SYSTEM CENTRAL BATTERY CONTROL UNIT



CCU SPECIFICATION



- INPUT :** 220 Vac. 50Hz. +/- 10%
- DC POWER OUTPUT :** 12 Vdc. Or 24 Vdc. 85 Watt up to 2000 Watt.
- REMOTE HEAD LAMP :** Halogen, Dichroic Halogen or Sealed Beam with adjustable and rubber anti-dust. The lamps are mounting on single or double bracket that can be installed in both wall or ceiling-mounted
- TYPE OF BATTERY :** SUNNY Sealed Lead Acid Battery Maintenance Free. ISO 9001 & Certified CE and UL Underwriters Laboratories Inc.
- BATTERY CHARGER :** Automatic Battery Charger, Solid-state Trickle Charge Constant Voltage limiting current.
- CHARGING PERIOD :** 10-15 Hours.
- PROTECTIONS :** Low / High Battery Charger Cut-Off
Low Voltage Cut-Off
Over / Under Voltage Input 220 Vac.
AC Fuse to prevent short circuit and overload for AC Input
DC circuit breaker to prevent short circuit and overload for DC Output
- INDICATORS :** LED AC POWER or AC indicates incoming 220Vac.
LED CHARGE or Charging indicates the battery is charging.
LED FULL indicates the battery is fully charging.
LED OVER indicates the battery over charging.
DC Voltmeter indicates voltage battery.
DC Ammeter indicates battery charging current.
SWITCH TEST test the output lamp and battery.
SWITCH ON/OFF control the output lamps.
- OPTION :** Automatic Test-Monthly Exercise.
Remote Test-Wireless Time Delay 1 up to 15 Minutes
- HOUSING :** Zinc Steel Sheet 1.6 mm. Thickness with Epoxy Powder and Stove Enamel coated. Anti-rust corrosion proof

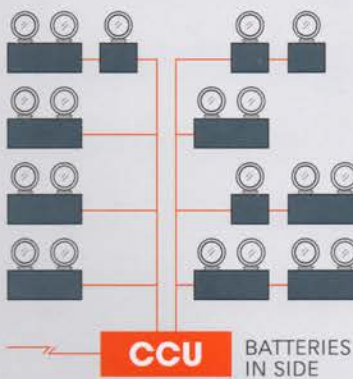

DIAGRAM



CCU CCU SERIES

-  REMOTE HEAD LAMP
1x35 WATT 12 VOLT
-  REMOTE HEAD LAMP
2x35 WATT 12 VOLT

CCU Series 12 Vdc. / 24 Vdc. OUTPUT

MODEL	DC OUTPUT VDC - WATT	BATTERY CAPACITY	BACK UP (Hours)	DIMENSION (mm.)			WEIGHT (kgs.)
				L	W	H	
CCU 12 - 85	12V - 85W	12V - 18Ah	2	390	100	250	12.7
CCU 12 - 115	12V - 115W	12V - 26Ah	2	400	155	250	19.6
CCU 12 - 180	12V - 180W	12V - 40Ah	2	400	190	250	30
CCU 12 - 300	12V - 300W	12V - 65Ah	2	500	200	260	45
CCU 12 - 350	12V - 350W	12V - 40Ah x2	2	500	250	300	50
CCU 12 - 450	12V - 450W	12V - 100Ah	2	500	250	300	70
CCU 12 - 475	12V - 475W	12V - 100Ah	2	500	250	300	70
CCU 12 - 550	12V - 550W	12V - 120Ah	2	500	300	550	80
CCU 12 - 720	12V - 720W	12V - 150Ah	2	650	400	700	90
CCU 12 - 1000	12V - 1,000W	12V - 200Ah	2	650	400	700	100
CCU 24 - 170	24V - 170W	12V - 18Ah x2	2	380	200	260	26.6
CCU 24 - 240	24V - 240W	12V - 26Ah x2	2	500	200	260	41
CCU 24 - 350	24V - 350W	12V - 40Ah x2	2	500	250	300	56
CCU 24 - 600	24V - 600W	12V - 65Ah x2	2	450	300	900	60
CCU 24 - 700	24V - 700W	12V - 40Ah x4	2	450	300	900	80
CCU 24 - 950	24V - 950W	12V - 100Ah x2	2	550	300	900	120
CCU 24 - 1100	24V - 1,100W	12V - 120Ah x2	2	600	300	900	134
CCU 24 - 1440	24V - 1,440W	12V - 150Ah x2	2	650	350	1000	140
CCU 24 - 2000	24V - 2,000W	12V - 200Ah x2	2	650	350	1,200	220

INVERTER SERIES

MAINTAINED SYSTEM CENTRAL BATTERY CONTROL UNIT HIGH VOLTAGE



INVERTER SPECIFICATION

- MODE OPERATION :** Maintained or Non-Maintained
- AC. INPUT :** 220 Vac. 50Hz. +/- 10%
- AC. OUTPUT :** 220 Vac. 50Hz. +/- 10%
- LAMP :** Incandescent, Compact Fluorescent, Halogen, Dichroic Halogen or Fluorescent
- TYPE OF BATTERY :** SUNNY Sealed Lead acid Battery Maintenance Free
- BATTERY CHARGER :** Automatic Battery Charger, Solid-State Trickle Charge, Constant voltage Limit Current
- CHARGING PERIOD :** 15 - 20 Hours.
- PROTECTIONS :** Low / High Battery Charger
Low Voltage Cut-Off
AC Input Circuit Breaker
DC Output Circuit Breaker
Battery Circuit Breaker
- HOUSING :** Zinc Steel Sheet 1 mm. Thickness with Epoxy Powder and Stove Enamel coated. Anti-rust corrosion proof
- INDICATORS :** LED MAIN indicates incoming 220 Vac.
LED INVERTER indicates inverter working.
LED BATTERY indicates battery voltage level. (Models)
LED LOAD indicates load level. (Models)
LED FAIL indicates fail and final voltage of battery.
AC VOLTMETER indicates AC voltage of input and output.
DC VOLTMETER indicates battery voltage.
SWITCH ON/OFF control inverter.
- OPTION :** Automatic Test

SINGLE LINE DIAGRAM

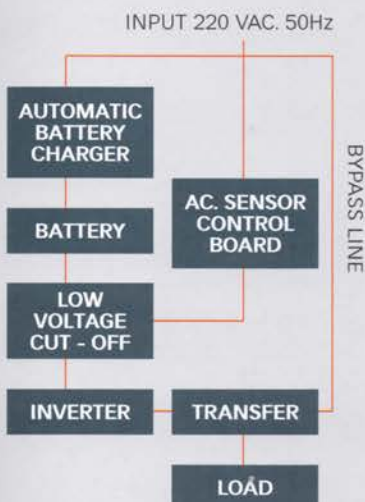

MODEL	DC OUTPUT VAC - WATT	BATTERY CAPACITY	BACK UP (Hours)	DIMENSION (mm.)			WEIGHT (kgs.)
				L	W	H	
INV 24 - 300	220V - 240W	12V - 33Ahx2	2	440	230	685	44.1
INV 24 - 500	220V - 400W	12V - 65Ahx2	2	570	250	765	80.6
INV 24 - 1000	220V - 800W	12V - 100Ahx2	2	640	250	995	106.1
INV 24 - 1500	220V - 1,200W	12V - 150Ahx2	2	560	570	1,040	175.6
INV 24 - 2000	220V - 1,600W	12V - 100Ahx4	2	560	570	1,040	214.6
INV 24 - 2500	220V - 2,000W	12V - 120Ahx4	2	560	570	1,040	232.8
INV 24 - 3000	220V - 2,400W	12V - 150Ahx4	2	560	670	1,140	292.8
INV 24 - 5000	220V - 4,000W	12V - 150Ahx8	2	1,060	670	1,140	542.6

EMERGENCY EXIT SIGN LUMINAIRES



19 LED
SELF-CONTAINED EMERGENCY
EXIT SIGN LUMINAIRES

20 EX
SELF-CONTAINED EMERGENCY
EXIT SIGN LUMINAIRES

21 EL
SELF-CONTAINED EMERGENCY
EXIT SIGN LUMINAIRES

22 SL
SELF-CONTAINED EMERGENCY
EXIT SIGN LUMINAIRES

22 SPECIAL ORDER
SELF-CONTAINED EMERGENCY
EXIT SIGN LUMINAIRES

**23 EMERGENCY EXIT SIGN
STANDARD SYMBOL**

24 ACCESSORIES

**25 RECHARGEABLE
BATTERIES**



LED SERIES



SL TYPE A,C



SL TYPE B



EX MODEL

FROM OF INSTALLATION

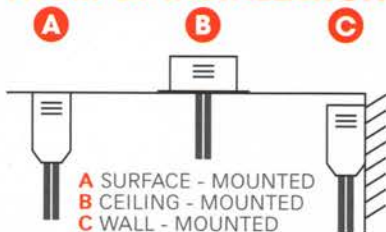

LED LAMP SPECIFICATION

- LAMP :** Light Emitting Diode (LED) Long Lifetime Operation
- SIGN PLATE :** The engraved sign on a Clear Acrylic Plate with the exit sign directional and letters in both Thai and English pointing the way a person should take as exit from that place in the event of power failure or fire
- MOUNTING :** The unit can be installed in Wall-Mounted Ceiling-Mounted (Recessed) or Surface-Mounted (Ceiling Hang) With Single Side or Double Side signs
- INPUT :** 220Vac. 50Hz +/- 10%
- TYPE OF BATTERY :** SUNNY HIGHTEMP METAL HYDRIDE BATTERY (NI-MH) 3.6V 1800mAh
- BATTERY CHARGER :** Automatic Battery Charger, Solid-state, Trickle Charge, Constant Voltage limiting Current, Charging Period 10-15 Hours.
- PROTECTIONS :** Low Voltage Cut-Off
- HOUSING :** AC Fuse to prevent short circuit and overload for AC Input
Steel Sheet or Electro-Galvanized Steel Sheet 1 mm. Thickness with Epoxy Powder and Stove Enamel coated, anti-rust corrosion proof
- INDICATORS :** LED AC indicates incoming 220Vac.
LED CHARGE indicates charging status
LED FULL indicates battery is fully charge
ON Switch to control the output lamps
OFF Switch to control the output lamps
TEST button to test the output lamps
- OPTION :** Sand Blasted on Clear Glass Sign Plate

MODEL	LAMP	LUMINOUS INTENSITY	SIDE	BATTERY CAPACITY	BACK UP (Hours)	DIMENSION (mm.)			WEIGHT (kgs.)
						L	W	H	
SLA188LED									
SLB188LED	LED	25,200 mcd	1	3.6V - 1800mAh.	3	400	60	60	1.5
SLC188LED									
SLA288LED									
SLB288LED	LED	25,200 mcd	2	3.6V - 1800mAh.	3	400	60	60	1.5

MODEL	LAMP	LUMINOUS INTENSITY	SIDE	BATTERY CAPACITY	BACK UP (Hours)	DIMENSION (mm.)			WEIGHT (kgs.)
						L	W	H	
EX188LED									
EX288LED	LED	40,320 mcd	1	3.6V - 1800mAh.	3	400	50	200	1.5



EX MODEL



EX N MODEL

EX SPECIFICATION

- LAMP :** Fluorescent or PL
- SIGN PLATE :** White Opal Diffuser screen with the exit directional and letters in both Thai and English pointing the way a person should take as exit from that place in the event of power failure or fire
- MOUNTING :** The unit can be installed in Wall-Mounted Ceiling-Mounted (Recessed) or Surface-Mounted (Ceiling Hang) With Single Side or Double Side signs
- INPUT :** 220Vac. 50Hz +/- 10%
- TYPE OF BATTERY :** SUNNY Sealed Lead Acid Battery Maintenance Free, ISO9001 & Certified with CE and UL Underwriters Laboratories Inc.
- BATTERY CHARGER :** Automatic Battery Charger, Solid-state, Trickle Charge, Constant Voltage limiting Current, Charging Period 10-15 Hours.
- PROTECTIONS :** Low Voltage Cut-Off
AC Fuse to prevent short circuit and overload for AC Input
DC Fuse to prevent short circuit and overload for DC Output
- HOUSING :** Steel Sheet or Electro-Galvanized Steel Sheet 1 mm. Thickness with Epoxy Powder and Stove Enamel coated, anti-rust corrosion proof.
- INDICATORS :** LED AC POWER indicates incoming 220Vac.
LED DC POWER indicates Outgoing 6Vdc.
ON-OFF Switch to control the output lamps
- OPTION :** Sealed Nickel Cadmium Battery, Maintenance Free
TEST button to test the output lamps

MODEL	LAMP		BATTERY CAPACITY	BACK UP (Hours)	DIMENSION (mm.)			WEIGHT (kgs.)
	BULB	WATT			L	W	H	
EX1FL10N S/D (AC)	1 FL	10	-	-	400	85	205	2.5
EX1PL11N S/D (AC)	1 PL	11	-	-	400	85	205	2.7
EX1FL10N S/D	1 FL	10	6V - 4.5Ah.	2	400	85	205	4
EX2FL10N S/D	2 FL	10						4.2
EX1PL11N S/D	1 PL	11	6V - 4.5Ah.	2	500	120	200	5
EX1FL10 S/D (AC)	1 FL	10						2.8
EX1PL11 S/D (AC)	1 PL	11	-	-	500	120	200	3
EX1FL10 S/D	1 FL	10	6V - 4.5Ah.	2	500	120	200	4
EX2FL10 S/D	2 FL	10						4.2
EX1PL11 S/D	1 PL	11	6V - 4.5Ah.	2	750	120	200	5
EX2PL11 S/D	2 PL	11						5.2
EX1FL18 S/D	1 FL	18	6V - 4.5Ah.	2	750	120	200	5.7
EX2FL18 S/D	2 FL	18						6.2



EL SPECIFICATION

- LAMP :** Fluorescent or PL
- SIGN PLATE :** The engraved sign on a Clear Acrylic Plate with the exit sign directional and letters in both Thai and English pointing the way a person should take as exit from that place in the event of power failure or fire
- MOUNTING :** The unit can be installed in Wall-Mounted Ceiling-Mounted (Recessed) or Surface-Mounted (Ceiling Hang) With Single Side or Double Side signs
- INPUT :** 220Vac. 50Hz +/- 10%
- TYPE OF BATTERY :** SUNNY Sealed Lead Acid Battery Maintenance Free, ISO9001 & Certified with CE and UL Underwriters Laboratories Inc.
- BATTERY CHARGER :** Automatic Battery Charger, Solid-state, Trickle Charge, Constant Voltage limiting Current, Charging Period 10-15 Hours.
- PROTECTIONS :** Low Voltage Cut-Off
AC Fuse to prevent short circuit and overload for AC Input
DC Fuse to prevent short circuit and overload for DC Output
- HOUSING :** Steel Sheet or Electro-Galvanized Steel Sheet 1 mm. Thickness with Epoxy Powder and Stove Enamel coated, anti-rust corrosion proof
- INDICATORS :** LED AC indicates incoming 220Vac.
LED CHARGE indicates charging status
LED FULL indicates battery is fully charge
ON Switch to control the output lamps
OFF Switch to control the output lamps
TEST button to test the output lamps
- OPTION :** Sealed Nickel Cadmium Battery, Maintenance Free
Sand Blasted on Clear Glass Sign Plate

MODEL	LAMP		BATTERY CAPACITY	BACK UP (Hours)	DIMENSION (mm.)			WEIGHT (kgs.)
	BULB	WATT			L	W	H	
EL1FL10/S (AC)	1 FL	10	6V - 4.5Ah.	2	500	80	200	2.5
EL1FL10/D (AC)	1 FL	10						
EL1PL11/S (AC)	1 PL	11						
EL1PL11/D (AC)	1 PL	11						
EL1FL10/S	1 FL	10	6V - 4.5Ah.	2	500	80	200	3.5
EL1FL10/D	1 FL	10						3.5
EL2FL10/S	2 FL	10						3.7
EL2FL10/D	2 FL	10						3.7
EL1PL11/S	1 PL	11	6V - 4.5Ah.	2	500	80	200	3.5
EL1PL11/D	1 PL	11						3.5
EL2PL11/S	2 PL	11						3.7
EL2PL11/D	2 PL	11						3.7

SL SERIES



SL TYPE A,C



SL TYPE B

FROM OF INSTALLATION

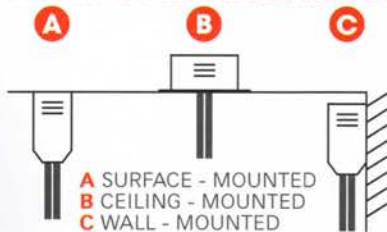

SL SPECIFICATION

- LAMP :** Fluorescent or PL.
- SIGN PLATE :** The engraved sign on a Clear Acrylic Plate with the exit sign directional and letters in both Thai and English pointing the way a person should take as exit from that place in the event of power failure or fire
- MOUNTING :** The unit can be installed in Wall-Mounted Ceiling-Mounted (Recessed) or Surface-Mounted (Ceiling Hang) With Single Side or Double Side signs
- INPUT :** 220Vac, 50Hz +/- 10%
- TYPE OF BATTERY :** SUNNY Sealed Lead Acid Battery Maintenance Free, ISO 9001 & Certified with CE and UL Underwriters Laboratories Inc.
- BATTERY CHARGER :** Automatic Battery Charger, Solid-state, Trickle Charge, Constant Voltage limiting Current, Charging Period 10-15 Hours.
- PROTECTIONS :** Low Voltage Cut-Off
 AC Fuse to prevent short circuit and overload for AC Input
 DC Fuse to prevent short circuit and overload for DC Output
- HOUSING :** Steel Sheet or Electro-Galvanized Steel Sheet 1 mm. Thickness with Epoxy Powder and Stove Enamel coated, anti-rust corrosion proof
- INDICATORS :** LED AC POWER indicates incoming 220Vac.
 LED DC POWER indicates outgoing 6Vdc.
 ON-OFF Switch to control the output lamps
- OPTION :** Sealed Nickel Cadmium Battery, Maintenance Free
 Sand Blasted on Clear Glass Sign Plate
 TEST button to test the output lamps

MODEL	LAMP		BATTERY CAPACITY	BACK UP (Hours)	DIMENSION (mm.)			WEIGHT (kgs.)
	BULB	WATT			L	W	H	
SL1FL10 (AC)	1 FL	10	-	-	500	110	110	2.5
SL1PL11 (AC)	1 PL	11						2.7
SL1FL10	1 FL	10	6V - 4.5Ah.	2	500	110	110	4.2
SL1PL11	1 PL	11						4.2
SL2FL10	2 FL	10	6V - 4.5Ah.	2	500	110	110	4.4
SL2PL11	2 PL	11						4.4

* H for SL TYPE A, C = 130 mm.



SPECIAL ORDER

MODEL	SIDE	LAMP		BATTERY CAPACITY	BACK UP (Hours)	DIMENSION (mm.)			WEIGHT (kgs.)
		BULB	WATT			L	W	H	
EX1FL10 (Fire Host)	1, 2	1	10	6V-4.5Ah.	2	500	120	450	6.5
EX3FL10 (Fire Host)	3	3	10	6V-4.5Ah. X3	2	575	470	450	13
EX1FL18	1, 2	1	18	6V-4.5Ah.	2	750	120	200	5.7
EX2FL36	1, 2	2	36	6V-4.5Ah. X2	2	1,300	150	300	10

EMERGENCY EXIT SIGN STANDARD SYMBOL



SD 001



SD 002



SD 003



SD 004



EF 001



EF 002



EF 003



EF 004



EF 005



EF 006



EF 007



EF 009



EF 010



EF 011



EF 012



EF 013



EF 015



EF 016



EF 017



EF 018



EF 019



EF 021



EF 022



EF 023



EF 024



EF 025



EF 026



EF 027

ACCESSORIES & RECHARGEABLE BATTERIES

HALOGEN LAMP



RDH 12 - 40 (P)
RDH 12 - 70 (P)
RDH 12 - 110 (P)
RDH 24 - 40 (P)
RDH 24 - 70 (P)
RDH 24 - 110 (P)
RDH 220 - 70 (P)
RDH 220 - 110 (P)



RCL 12 - 70 RCL 24 - 70
RCL 12 - 110 RCL 24 - 110



RSM 12 - 70 RSM 24 - 70
RSM 12 - 110 RSM 24 - 110



RSM 12 - 35 RSM 24 - 35
RSM 12 - 55 RSM 24 - 55



JC 6VOLT - 10W
JC 12VOLT - 10W
JC 12VOLT - 20W
JC 12VOLT - 25W
JC 12VOLT - 35W
JC 12VOLT - 50W
JC 12VOLT - 55W



DLJ151



HD 08
HD 16

DL 12V - 20W
DL 12V - 35W
DL 12V - 55W
DL 24V - 35W
DL 24V - 55W



DICHOIC HALOGEN LAMP TYPE (MR16+C)

6VOLT - 6W 24VOLT - 35W
12VOLT - 20W 24VOLT - 55W
12VOLT - 25W 220VAC - 35W
12VOLT - 35W 220VAC - 55W
12VOLT - 55W



BATTERY PACK FOR HALOGEN 12V - 20W, 35W



BATTERY PACK FOR FL 10W - 40W



ELECTRONIC TRANSFORMER (ELT) 12V - 50W



REMOTE TEST - WIRELESS

LED



RDH 12 - 3 LED SURFACE
RDH 12 - 6 LED SURFACE
RDH 12 - 10 LED SURFACE



RDH 12 - 6 LED SURFACE
RDH 12 - 12 LED SURFACE
RDH 12 - 20 LED SURFACE



RDH 12 - 3 LED WALL
RDH 12 - 6 LED WALL
RDH 12 - 10 LED WALL



RDH 12 - 6 LED WALL
RDH 12 - 12 LED WALL
RDH 12 - 20 LED WALL



DLJ151 3 LED
DLJ151 6 LED
DLJ151 10 LED



HD08 3LED HD16 3LED

DL 12V - 3W LED
DL 12V - 6W LED



POWER LED LAMP TYPE (MR16+C)
12V - 3W, 6W, 10W
COOL WHITE & WARM WHITE



BATTERY PACK FOR LED BATTERY 12V - 1.2AH. FOR 12V - 3W LED LAMP

ACCESSORIES & RECHARGEABLE BATTERIES



SEALED LEAD ACID MAINTENANCE FREE



TECHNICAL FEATURES

Sealed Construction

SUNNY's unique construction and sealing technique ensure that no electrolyte leakage can occur from the terminals or cases of any SN batteries. This Feature ensures safe and efficient operation of SN batteries in any position.

Absorbent Glass Mat System

SN batteries make use of fine mat separators (glass fiber) wherein sufficient electrolyte is absorbed to provide longest life and steady

service. This system prevents escape of electrolyte from the separator which causes leakage.

Gas Recombination

SN batteries incorporate a unique design that effectively controls generation of gas and allows recombination of over 99% of gas generated during the normal use.

Maintenance-Free Operation

During the expected floating service life of SN batteries there is no need to check the specific gravity of the electrolyte, or add water, which means they require no maintenance service.

Position-Free and Leakage-Free

The combination of the sealed construction and the use of absorbent mat separators permits operation of SN batteries in any position without loss of capacity, electrolyte, nor service life. The SN batteries are made to operate in any position.

Low Pressure Venting System

SN batteries are equipped with a safe, and low pressure venting system, which operates at 7 psi to 10 psi, automatically releasing excess gas in the event that gas pressure rises to a level above the normal rate ensuring no excessive buildup of gas in the batteries. Safety valves are automatically released once the pressure is return to normal rate.

Heavy-Duty Grids

The SN heavy-duty lead-calcium alloy grids provide an extra performance and service life in both cyclic and floating applications even in deep discharge condition.

Cyclic Life

Depending on the average depth of discharge, over 1,000 discharge/recharge cycles can be expected from SN batteries.

Float Life

The expected life of SN batteries under float (trickle charge) use is 3 to 5 years.

Low Self-discharge / Long shelf life

At an ambient temperature 20°C (68°F), the self-discharge rate of SN batteries is only 3% (approx) of rated capacity per month. The low self-discharge rate permits storage of SN batteries for up to one year without significant loss of efficiency or appreciable deterioration performance.

Operating Temperature Range

SN batteries may be used over a board range of ambient temperatures permitting flexible system design and location.

High Recovery Capability

SN batteries have an excellent charge acceptance and recovery capability even after deep discharge.

DISCHARGE CURRENT & DISCHARGE DURATION TIME

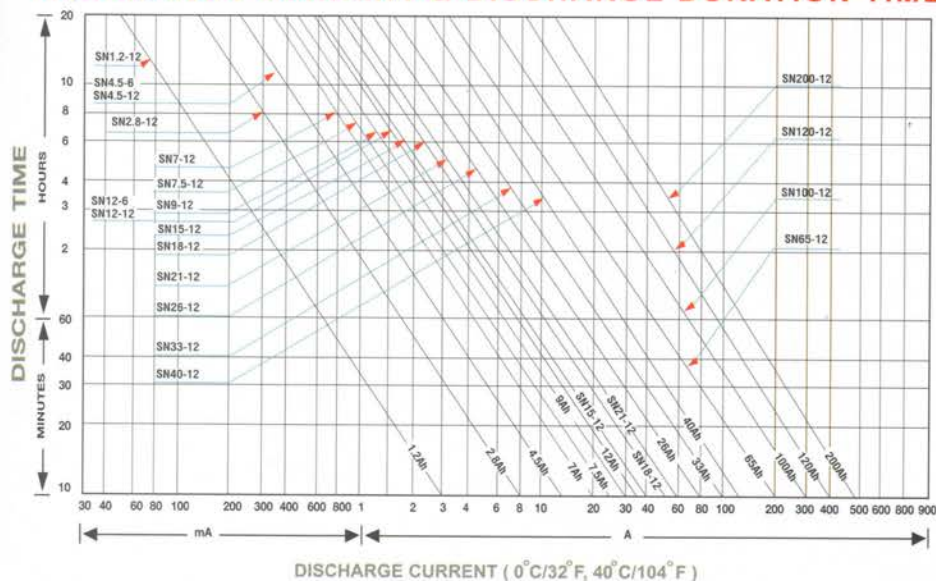

ACCESSORIES & RECHARGEABLE BATTERIES



SEALED LEAD ACID MAINTENANCE FREE

BATTERY MODEL	NORMAL VOLTAGE (V)	RATED CAPACITY (AH.) TO FINAL VOLTAGE PER CELL				DIMENSION (mm.)					TERMINAL
		1.75 (20HR)	1.75 (10HR)	1.75 (5HR)	1.75 (1HR)	LENGTH	WIDTH	HEIGHT	TOTAL HEIGHT	WEIGHT (kg.)	
SN 4.5-6	6	4.5	4.2	3.8	2.7	70	47	101	105	0.82	F1
SN 12-6	6	12	11.2	10.2	7.2	151	51	95	100	1.96	F1
SN 1.2-12	12	1.2	1.14	1.02	0.54	97	48	53	58	0.56	F1
SN 2.8-12	12	2.8	2.6	2.4	1.6	66	66	95	100	1.11	F1
SN 4.5-12	12	4.5	4.2	3.8	2.6	91	71	100	105	1.63	F1
SN 7-12	12	7	6.5	6	4	151	66	95	100	2.35	F1
SN 7.5-12	12	7.5	7	6.4	4.5	151	66	95	100	2.56	F1
SN 9-12	12	9.0	8.5	7.7	5.4	151	66	95	100	2.85	F1
SN 12-12	12	12	11	10.2	7.2	151	99	95	100	4.10	F1
SN 15-12	12	15	14	12.8	9	180	77	168	-	5.35	L1
SN 18-12	12	18	16.7	15.3	10.8	180	77	168	-	6.15	L1
SN 21-12	12	21	19.5	17.9	12	180	77	168	-	6.30	L1
SN 26-12	12	26	24.2	22.1	15.6	166	175	125	-	9.75	L1
SN 33-12	12	33	30.7	28.1	18.8	196	131	156	180	11.8	A2
SN 40-12	12	40	37.2	34.2	22.8	198	166	171	-	14.0	B1,A5
SN 65-12	12	65	60.5	55.3	37.1	348	168	178	-	22.8	B2,A3
SN 100-12	12	100	93	85	57	328	172	214	217	30.0	B2
SN 120-12	12	120	111.6	102	68.4	406	174	208	233	38.2	A6
SN 150-12	12	150	139.5	127.5	85.5	487	170	241	-	47.8	A6
SN 200-12	12	200	186	170	114	522	240	219	244	66.4	A7



Ni-Mh Battery Pack (AA Size)

HIGHTEMP NICKEL METAL HYDRIDE BATTERY

All data involves voltage and weight to stack-up battery are equal to the value of unit cell time the number of unit cell which consisted in the stack-up batteries. Nominal voltage of unit cell = 1.2V

DESCRIPTION	SPECIFICATION	UNIT
Nominal Voltage	3.6V	v
Nominal capacity	1800	mAh
Standard Charge	180	mA
	14 - 16	Hour
Fast Charge	1800 (1C)	mA
	1.5 approx	Hour
Tickle Charge	0.05C - 0.1C	mA
Discharge Cut-Off Voltage	1.0	V/Cell
Storage Temperature	-30 - 65	°c
Weight	200	gram
Dimension	150 x 15 x 15	mm



เงื่อนไขการรับประกันสินค้า

แผงวงจร รับประกัน 5 ปี

แบตเตอรี่ 6 VOLT รับประกัน 18 เดือน

แบตเตอรี่ 12 VOLT รับประกัน 2 ปี



TIS.1102-2538



TIS.1955-2551

